

# Catégorie

# **BOITES**



Boîte de dérivation encastrée

**STOPAIR**  
**MULTIMAT**

170X170/P40 avec couvercle

Page 24



PAGE 16  
ENCASTRÉES



STOP AIR



CLOISONS  
SÈCHES



MAÇONNERIE



MAÇONNERIE

PAGE 24  
DE DÉRIVATION



STOP AIR



CLOISONS SECHES  
& COMBLE

PAGE 27  
LUMINAIRES



POINT DE  
CENTRE



APPLIQUE

PAGE 28  
ÉTANCHES



IP 54



IP 55



IP56

Encastrement

# BOITES D'ENCASTREMENT STOP AIR MULTIMATÉRIEAUX

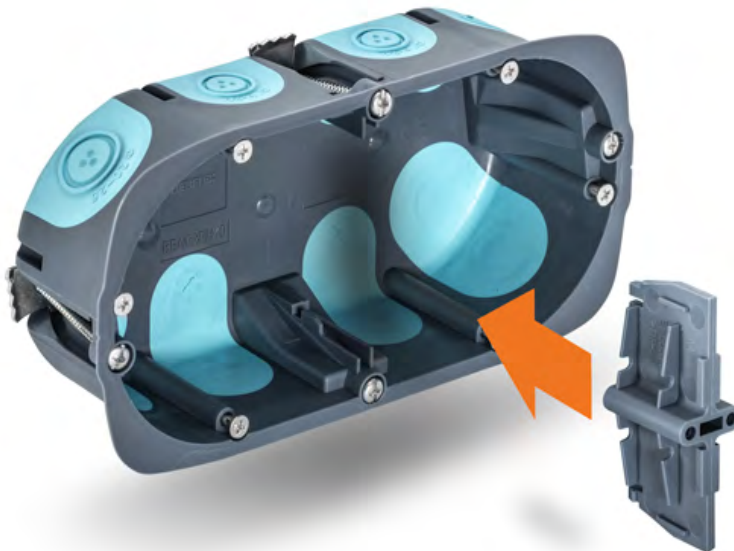
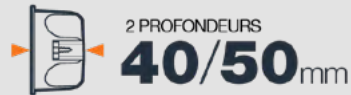

- Conforme RE 2020
- Réduit les flux d'air
- Économie d'énergie
- Installation multi-supports
- Injection bi-matière



Boîte à encastrer avec étriers guidés et vis à pas rapide pour assurer la fixation au mur.



Séparateur courants faibles / courants forts amovible.



Passes câbles par membranes élastoplastiques pour assurer l'étanchéité à l'air requis pour les constructions à basse consommation.



718382  
BOITE D'ENCASTREMENT  
STOPAIR MULTIMATERIAUX  
1 POSTE Ø67/P40



718386  
BOITE D'ENCASTREMENT  
STOPAIR MULTIMATERIAUX  
3 POSTES H/V Ø67/P40

BOITE D'ENCASTREMENT STOP AIR MULTIMATERIAUX	GENCOD	PACKAGING	PCB	PCB CARTON
1 POSTE Ø85/P40	314218 <b>718036</b> 0	VRAC	5	60
1 POSTE Ø67/P40	314218 <b>718382</b> 8	SOUS FILM	10	100
1 POSTE Ø67X40 LOT DE 5	314218 <b>718331</b> 6	SOUS FILM	1	25
1 POSTE Ø67/P50	314218 <b>718384</b> 2	SOUS FILM	5	100
1 POSTE Ø67/P50 LOT DE 5	314218 <b>718122</b> 0	0	1	50
1 POSTE Ø67/P50 LOT DE 50	314218 <b>718123</b> 7	BOITE OPAQUE	1	EN COURS
2 POSTES H/V Ø67/P40	314218 <b>718385</b> 9	SOUS FILM	5	50
3 POSTES H/V Ø67/P40	314218 <b>718386</b> 6	SOUS FILM	5	25
1P Ø67/P40 FILET DE 30	314218 <b>718041</b> 4	FILET	1	4
1 POSTE Ø67/P40 SILO DE 200	314218 <b>800025</b> 4	SILO	1	1
2 POSTES Ø67/P40 1/2 SILO DE 30	314218 <b>800033</b> 9	1/2 SILO	1	1
3 POSTES Ø67/P40 1/2 SILO DE 20	314218 <b>800036</b> 0	1/2 SILO	1	1

## PRODUITS ASSOCIÉS



CABLES & CONDUITS  
**GAINE ICTA**  
Ø16 à 25  
5, 10, 25, 50 et 100 M

PAGE 68



CLOISONS SÈCHES  
**SCIE CLOCHE**  
DIAMÈTRE 67 MM

REF.718421

PAGE 19



STOP AIR MULTIMATERIAUX  
**BOITE D'ENCASTREMENT**  
STOPAIR MULTIMAT  
1 POSTE Ø67/P40  
FILET DE 30

REF.718041

PAGE 17

## BÉTON CELLULAIRE



## PARPAINGS

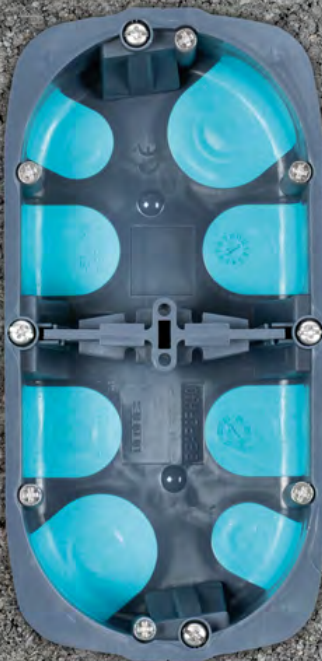

## PLAQUES DE PLÂTRE



Encastrement

# CLOISON SÈCHE

La boîte référence

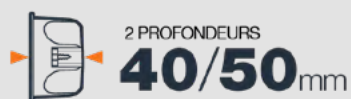

- Entrées latérales ou arrières
- Étriers de serrage
- Compatible griffes de fixation

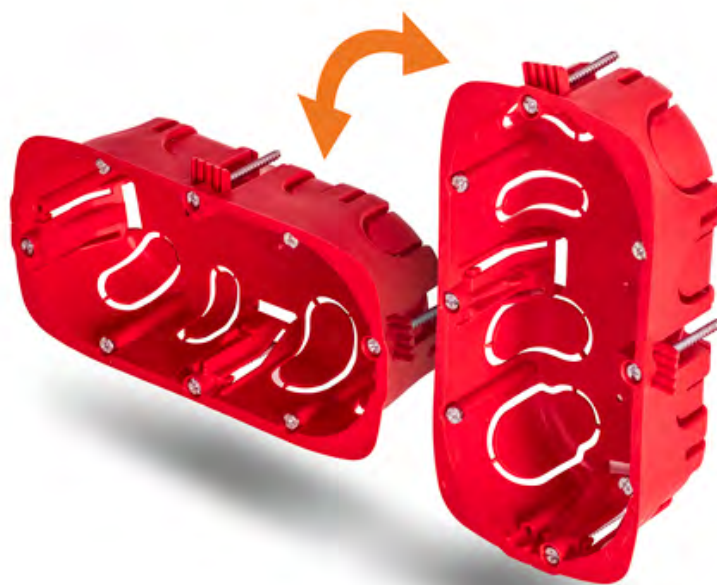

Boîte à encastrer avec étriers en plastique pour un fort pouvoir de maintien au mur.



Large espace de câblage : facilité d'accès pour un branchement idéal.



Installation de l'appareillage par vis avec rattrapage d'aplomb ou par griffes avec stries de fixation.



718021  
BOITE D'ENCASTREMENT  
CLOISON SECHE  
1 POSTE Ø67/P50



718025  
BOITE D'ENCASTREMENT  
CLOISON SECHE 2 POSTES  
DOUBLE SENS Ø67/P40

 **Produit malin  
GABARIT DE POSE**



BOITE D'ENCASTREMENT <b>CLOISON SECHE</b>	GENCOD	PACKAGING	PCB	PCB CARTON
1 POSTE Ø67/P40 GRIS LOT DE 10	314218 <b>718005</b> 6	SOUS FILM	1	20
1 POSTE Ø67/P40	314218 <b>718011</b> 7	VRAC	10	200
1 POSTE Ø67/P40 LOT DE 50	314218 <b>718121</b> 3	0	1	0
1 POSTE Ø67/P50	314218 <b>718021</b> 6	VRAC	5	150
1 POSTE Ø85/P50	314218 <b>718380</b> 4	SOUS FILM	5	160
1 POSTE Ø67/P40 LOT DE 10	314218 <b>718014</b> 8	SOUS FILM	1	20
1 POSTE Ø67/P40 X10 + SCIE CLOCHE	314218 <b>718374</b> 3	SOUS FILM PEGBOAR- DABLE	1	25
2 POSTES DOUBLE SENS Ø67/P40	314218 <b>718762</b> 8	SOUS FILM	10	150
2 POSTES DOUBLE SENS Ø67/P40	314218 <b>718025</b> 4	VRAC	5	100
3 POSTES DOUBLE SENS Ø67/P40	314218 <b>718031</b> 5	VRAC	5	60
1 POSTE Ø67/P40 1/2 SILO DE 100	314218 <b>800031</b> 5	1/2 SILO	1	1
1 POSTE Ø67/P40 SILO DE 200	314218 <b>800027</b> 8	SILO	1	1
2 POSTES Ø67/P40 1/2 SILO DE 30	314218 <b>800035</b> 3	1/2 SILO	1	1
SCIE CLOCHE Ø67	314218 <b>718421</b> 4	SOUS FILM PEGBOAR- DABLE	5	50
GABARIT DE POSE POUR BOITE D'ENCASTREMENT	314218 <b>718890</b> 8	VRAC	10	80

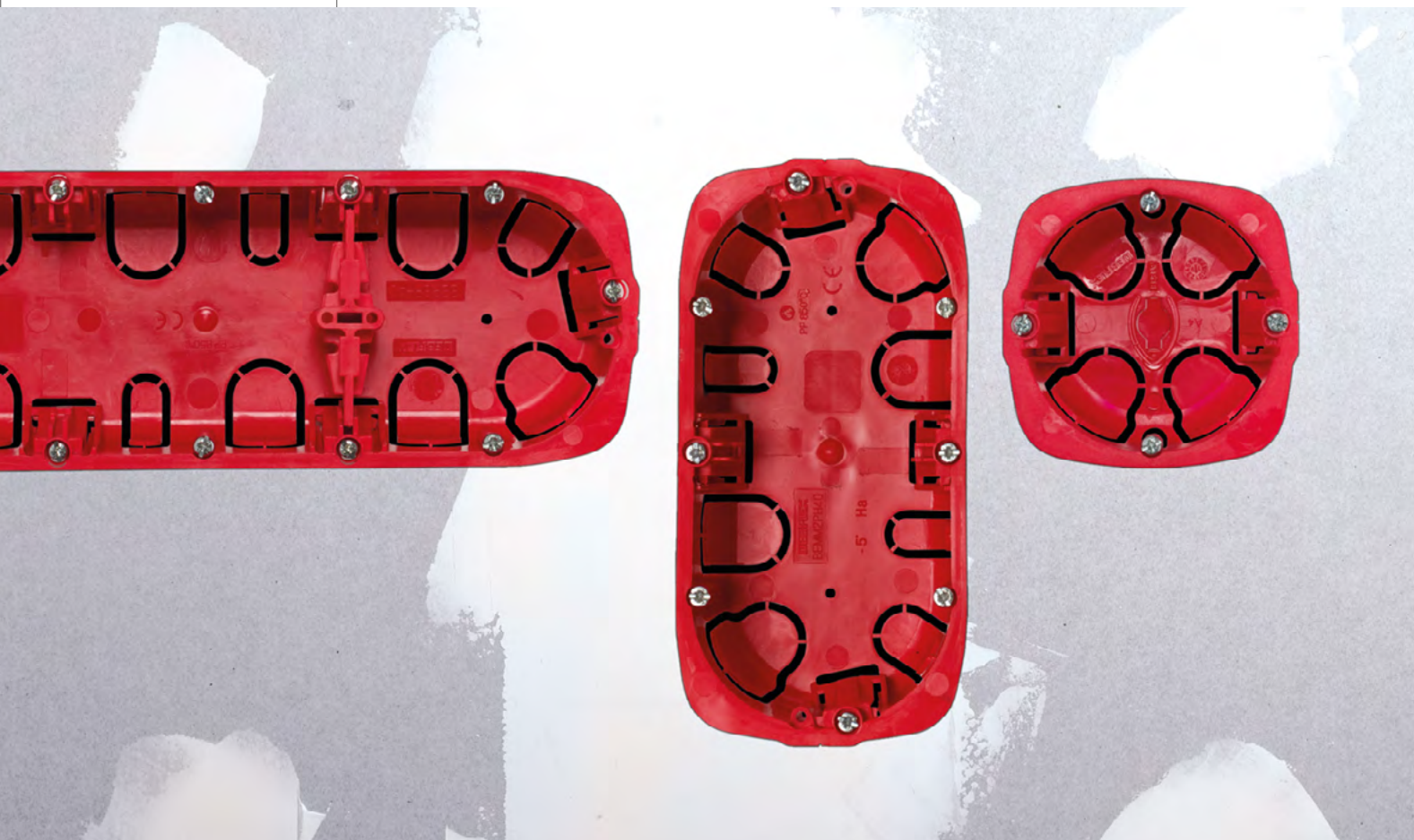

Encastrement

# MULTIMATERIAUX

## Dédiées au gros œuvre

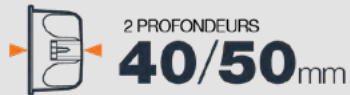

- Entrées latérales ou arrières
- Étriers de serrage
- Installation multi-supports

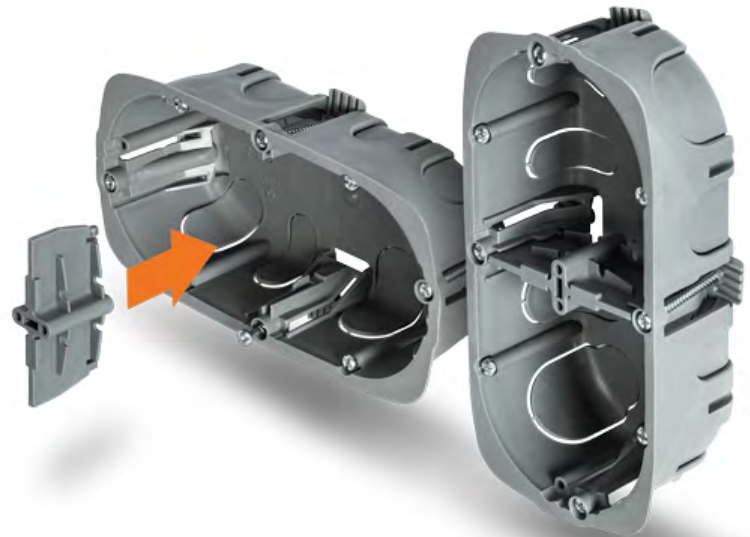

Boîte à encastrer avec étriers guidés ou par scellement.



Séparateur courants faibles / courants forts amovible.



Opercule sécable par simple pression.



718455  
BOITE D'ENCASTREMENT  
MULTIMATÉRIAUX  
D67/P40

BOITE D'ENCASTREMENT MULTIMATÉRIAUX	GENCOD	PACKAGING	PCB	PCB CARTON
1 POSTE D67/P30	314218 718604 1	0	10	10
GRIS D67/P40 1P x1 CUTCASE DE 80	314218 718455 9	0	1	80
GRIS D67/P40 2P x1 CUTCASE DE 45	314218 718456 6	0	1	45
GRIS D67/P40 3P x1 CUTCASE DE 26	314218 718457 3	0	1	26

## PRODUITS ASSOCIÉS



CABLES & CONDUITS  
GAINE ICTA  
Ø16 0 25  
5, 10, 25, 50 et 100 M  
REF.415005  
**PAGE 68**



CABLES & CONDUITS  
COURONNE DE CABLE  
HO7V-U 1.5 MM² 100 M  
BLEU  
REF.110007  
**PAGE 60**



CASUAL EVO  
PRISE DE COURANT  
2P+T PUIT AFFLEURANT  
NOIR  
REF.739120  
**PAGE 08**

**BÉTON  
CELLULAIRE**

**PARPAINGS**

**PLAQUES  
DE PLÂTRE**





Encastrement

# MAÇONNERIE

## Dédiées aux murs pleins

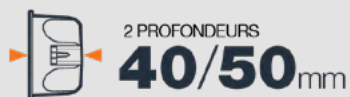

- Ultra résistante
- Résiste au phénomène de compression du ciment
- Juxtaposable pour appareillage multipostes

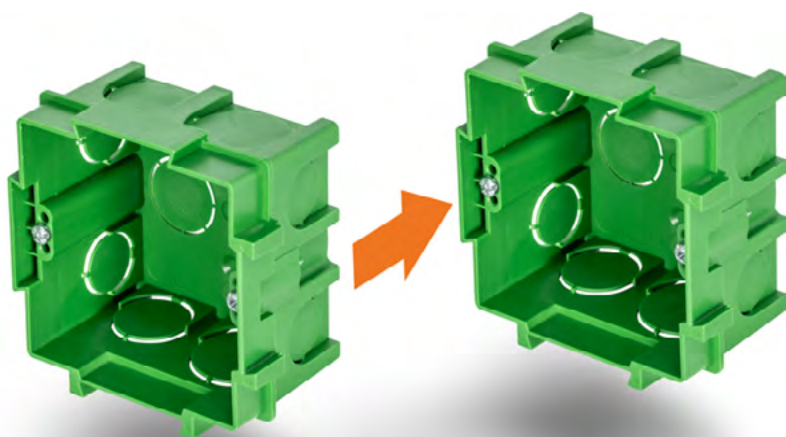

Nos boîtes sont équipées de 3 trous de fixation afin de positionner l'appareillage d'aplomb.



718035  
BOITE D'ENCASTREMENT  
MAÇONNERIE  
1 POSTE Ø67/P40

BOITE D'ENCASTREMENT MAÇONNERIE	GENCOD	PACKAGING	PCB	PCB CARTON
1 POSTE Ø67/P40	314218 <b>718035</b> 3	VRAC	10	220
1 POSTE Ø67/P40 BLANC LOT DE 10	314218 <b>718348</b> 4	SOUS FILM	10	60
1 POSTE 75X75/P40	314218 <b>718032</b> 2	VRAC	1	150
2 POSTES 67X153/P40	314218 <b>718310</b> 1	SOUS FILM	5	150

## PRODUITS ASSOCIÉS



CABLES & CONDUITS  
GAINE ICTA  
Ø16 à 25  
5, 10, 25, 50 et 100 M

PAGE 76



CABLES & CONDUITS  
COURONNE DE CABLE  
HO7V-U 1.5 MM² 100 M  
BLEU

REF.110007

PAGE 67



CASUAL EVO  
PRISE DE COURANT  
2P+T PUIT AFFLEURANT

REF.749658

PAGE 07

**BRIQUES**

**PARPAINGS**

**BÉTON  
CELLULAIRE**



De dérivation

# STOP AIR

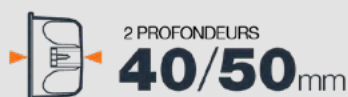

- Conforme RE 2020
- Réduit les flux d'air
- Économie d'énergie
- Installation multi-supports
- Injection bi-matière



Gorge, collerette large et ergots pour un meilleur maintien de la boîte pendant la pose



Perçage des entrées/sorties sans outils et l'élasticité des entrées/sorties permettant d'épouser parfaitement les contours de la gaine



718871  
**BOITE DE DERIVATION  
 ENCASTREE STOPAIR MULTIMAT  
 + COUVERCLE**  
 Ø85/P40

BOITE DE DERIVATION ENCASTREE + COUVERCLE <b>STOP AIR MULTIMATERIAUX</b>	GENCOD	PACKAGING	PCB	PCB CARTON
Ø67/P40	314218 <b>718870</b> 0	SOUS FILM	10	60
Ø85/P40	314218 <b>718871</b> 7	SOUS FILM	10	30
100X100/P40	314218 <b>718866</b> 3	SOUS FILM	5	30
170X110/P40	314218 <b>718867</b> 0	SOUS FILM	5	20
170X170/P40	314218 <b>718868</b> 7	SOUS FILM	2	12
270X200/P50	314218 <b>718869</b> 4	SOUS FILM	2	6

## PRODUITS ASSOCIÉS



CABLES & CONDUITS  
**GAINE ICTA**  
 Ø16 à 25  
 5, 10, 25, 50 et 100 M  
**PAGE 68**



CABLES & CONDUITS  
**BORNE AUTOMATIQUE**  
 DE 2 À 8 ENTREES  
 SECTION 1.5 A 2.5 MM<sup>2</sup>  
**PAGE 75**



CABLES & CONDUITS  
**COURONNE DE CABLE**  
 U1000R2 V 3G1.5 MM<sup>2</sup>  
 100 M NOIR  
**PAGE 60**

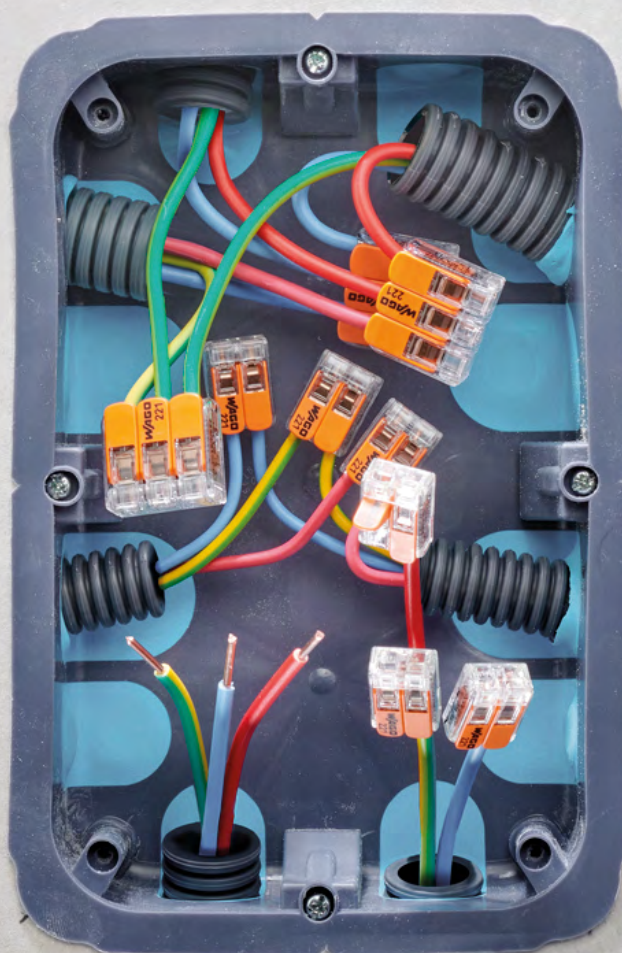

Les boîtes encastrées  
 Stop Air réduisent les  
 fuites d'air provenant  
 de l'extérieur de 90%

Dérivation cloison sèches

# BOITES DE COMBLE ET COUVERCLES



703990  
**BOITE DE COMBLE SAILLIE  
AVEC COUVERCLE 300X300/P95**

## DERIVATION CLOISON SECHE & COMBLE

	GENCOD	PACKAGING	PCB	PCB CARTON
BOITE DE DERIVATION ENCASTREE CLOISON SECHE AVEC COUVERCLE 100X100/P40	314218 <b>718600</b> 3	SOUS FILM	5	30
BOITE DE COMBLE SAILLIE AVEC COUVERCLE 300X300/P95	314218 <b>703990</b> 3	SOUS FILM	1	3



703990  
**COUVERCLE A CLIPSER Ø86**

## DERIVATION ET ENCASTREMENT COUVERCLES

	GENCOD	PACKAGING	PCB	PCB CARTON
COUVERCLE A CLIPSER Ø86 BLANC	314218 <b>718680</b> 5	SOUS FILM	10	200
COUVERCLE ROND A VISSER D86 POUR BOITE D67 SANS VIS	314218 <b>718116</b> 9	SOUS FILM	1	200
COUVERCLE CARRE A VISSER 85X85 POUR BOITE D67 SANS VIS	314218 <b>718115</b> 2	SOUS FILM	10	300
COUVERCLE CARRE A VISSER 108x108 POUR BOITE D85	314218 <b>718612</b> 6	SOUS FILM	1	270
COUVERCLE ROND A CLIPSER D118	314218 <b>718605</b> 8	SOUS FILM	5	175

Luminaires

# POINT DE CENTRE ET APPLIQUE

Conçues pour effectuer vos connexions de luminaire au plafond comme au mur.



718921  
**BOÎTE LUMINAIRE DCL STOPAIR MULTIMATERIAUX Ø67/P50**



718602  
**BOÎTE APPLIQUE DCL STOPAIR MULTIMATERIAUX D54/P40**

BOÎTE LUMINAIRE POINT DE CENTRE	GENCOD	PACKAGING	PCB	PCB CARTON
MAÇONNERIE Ø67/P50	314218 <b>718930</b> 1	SACHET	5	125
DCL MAÇONNERIE Ø67/P50 + DOUILLE B22	314218 <b>718945</b> 5	SACHET	1	100
CLOISON SECHE Ø67/P50	314218 <b>718914</b> 1	SACHET	10	120
DCL STOPAIR MULTIMATERIAUX Ø67/P50 + CROCHET	314218 <b>718921</b> 9	SACHET	4	60
DCL STOPAIR MULTIMATERIAUX D67/50 GRIS BLEU + DOUILLE B22 + FICHE DCL + CROCHET	314218 <b>718124</b> 4	0	10	0
DCL STOPAIR MULTIMATERIAUX D67/50 GRIS BLEU + DOUILLE B22 + FICHE DCL + CROCHET LOT X 3	314218 <b>718619</b> 5	0	10	0
DCL STOPAIR MULTIMATERIAUX D67/50 + DOUILLE E27 + FICHE DCL + CROCHET	314218 <b>718606</b> 5	SACHET	5	
DCL STOPAIR MULTIMATERIAUX D67/50 GRIS BLEU + DOUILLE E27 + FICHE DCL + CROCHET LOT X 3	314218 <b>718622</b> 5	0	10	
DCL CLOISON SECHE D67/P50 + CROCHET	314218 <b>718609</b> 6	SACHET	5	
POINT DE CENTRE STOPAIR MULTIMATERIAUX D67/P50 + CROCHET	314218 <b>718608</b> 9	SACHET		
COUVERCLE DCL APPLIQUE DIAM 88 POUR BOÎTE D67	314218 <b>718125</b> 1	SOUS FILM	10	200
CROCHET METAL FILETÉ POUR / SACHET X2 PDTS VERSION CROSS	314218 <b>718978</b> 3	SACHET	18	720

BOÎTE APPLIQUE	GENCOD	PACKAGING	PCB	PCB CARTON
DCL STOPAIR MULTIMATERIAUX D54/P40	314218 <b>718602</b> 7	SACHET	5	100

Dérivation étanche

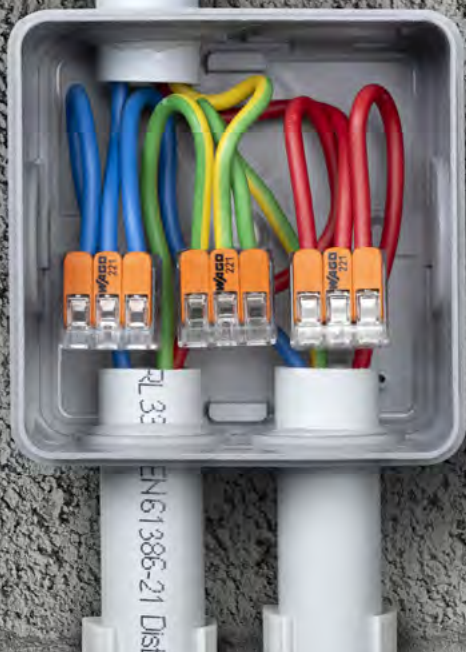

# ÉTANCHES

Les boîtes de dérivation étanches en saillie sont indispensables si le local présente un risque d'humidité

ETANCHEITE  
**IP54**

ETANCHEITE  
**IP55**

ETANCHEITE  
**IP66**

FABRIQUÉ EN  
FRANCE



- Bi-matière
- Étanchéité optimale
- Compatible câbles et tubes IRL
- Gamme large IP54 à 66



Passerelle  
élastoplastique pour une  
étanchéité optimale.



Couvercle à ouverture  
sans vis



Emplacement fileté  
pour l'installation avec  
une cheville de fixation.



718811  
BOITE DE DERIVATION  
IP54 Ø70/P40



718806  
BOITE DE DERIVATION  
IP55 85X85/P50



718050  
BOITE DE DERIVATION  
IP55 170X100/P80

BOITE DE DERIVATION ETANCHES	GENCOD	PACKAGING	PCB	PCB CARTON
IP54 Ø70/P40 GRIS LOT DE 3	314218 <b>718811</b> 3	SOUS FILM	1	50
IP54 Ø70/P40 GRIS LOT DE 50	314218 <b>718818</b> 2		1	0
IP54 85X85/P50 GRIS LOT DE 3	314218 <b>718813</b> 7	SOUS FILM	1	50
IP54 85X85/P50 GRIS LOT DE 50	314218 <b>718817</b> 5	0	1	0
IP54 115X115/P60 GRIS LOT DE 3	314218 <b>718814</b> 4	SOUS FILM	1	10
IP55 Ø70/P40 GRIS	314218 <b>718802</b> 1	VRAC	10	200
IP55 Ø85/P50 GRIS	314218 <b>718804</b> 5	VRAC	10	120
IP55 85X85/P50 GRIS	314218 <b>718806</b> 9	VRAC	10	120
IP55 115X115/P60 GRIS	314218 <b>718808</b> 3	VRAC	5	50
IP55 170X100/P80 GRIS	314218 <b>718050</b> 6	VRAC	3	36
IP55 170X170/P80 GRIS	314218 <b>718060</b> 5	VRAC	2	30
IP55 210X170/P80 GRIS	314218 <b>718070</b> 4	VRAC	1	20
IP55 310X240/P120 GRIS	314218 <b>718080</b> 3	VRAC	1	10
IP66 Ø85/P50 GRIS	314218 <b>718205</b> 0	VRAC	10	120
IP66 85X85/P50 GRIS	314218 <b>718215</b> 9	VRAC	10	120
IP66 115X115/P60 GRIS	314218 <b>718225</b> 8	VRAC	5	50
IP66 Ø85/P50 BLANC	314218 <b>718235</b> 7	VRAC	10	120
IP66 85X85/P50 BLANC	314218 <b>718245</b> 6	VRAC	10	120
IP66 115X115/P60 BLANC	314218 <b>718255</b> 5	VRAC	5	50

## PRODUITS ASSOCIÉS



Câble et Conduits  
**TUBE IRL 3321**  
Ø16 à 25 MM  
LONGUEUR 2M / GRIS

PAGE 69



CABLES & CONDUITS  
**GAINE ICTA**  
Ø16 0 25  
5, 10, 25, 50 et 100 M

PAGE 68



CABLES & CONDUITS  
**BORNE AUTOMATIQUE**  
DE 2 À 8 ENTREES  
SECTION 1.5 A 2.5 MM<sup>2</sup>

PAGE 75

